

USER GUIDE TOPLINE INSTRUMENTS

SUMMARY

1. INTRODUCTION.....	4
2. COMMON CHARACTERISTICS OF THE SIMPLE, DOUBLE AND WIND MULTIFUNCTIONS	4
2.1 MAIN CHANNELS – USED TO SELECT DATA FOR DISPLAY	4
2.2 SECONDARY CHANNELS – USED TO CONFIGURE AND CALIBRATE THE SYSTEM.....	4
2.3 SELECTING THE LANGUAGE.....	6
2.4 LIGHTING.....	6
2.5 ALARMS.....	6
3. WIND MULTIFUNCTION DISPLAY TOPLINE.....	7
4. TOPLINE CHANNELS	8
4.1 SPEEDO	9
4.2 TRIP LOG.....	9
4.3 LOG GENERAL.....	9
4.4 WINDSPEED	9
4.5 APPARENT WIND ANGLE.....	10
4.6 COMPASS	10
4.7 RACE TIMER	10
4.8 DEAD RECKONING.....	11
4.9 TRUE WIND SPEED	11
4.10 TRUE WIND ANGLE.....	11
4.11 TRUE WIND DIRECTION.....	12
4.12 VMG (VELOCITY MADE GOOD).....	12
4.13 VMC (COURSE MADE GOOD).....	12
4.14 AIR TEMPERATURE.....	13
4.15 SEA TEMPERATURE.....	13
4.16 BATTERY VOLTAGE.....	13
5. TOPLINE MULTIFUNCTIONS REMOTE CONTROL (TYPE BEFORE MID-2001)	14
5.1 UTILISATION.....	14
5.2 LIGHTING.....	14
5.3 TRIGGERING THE RACE TIMER FROM THE REMOTE CONTROL.....	15
6. REMOTE CONTROL FOR MULTIFUNCTIONS (SINCE MID-2001)	15
6.1 PRESENTATION.....	15
6.2 OPERATION.....	16
? ON THE FOLLOWING DISPLAY TYPES (MS 13 – MD 13 – MD 18 – PERFORMANCE – TRIPLE 25 – MS 40).....	16
? ON THE FOLLOWING DISPLAY TYPES (MS 13 – MD 13 – MD 18 – PERFORMANCE – TRIPLE 25 – MS 40).....	17
7. SETTING UP THE SYSTEM FOR USE.....	17
7.1 ADJUSTING THE ELECTROMAGNETIC SPEEDO.....	17
7.2 CALIBRATION OF THE SPEED / LOG FUNCTION	18
7.3 CALIBRATION OF THE WIND SPEED FUNCTION.....	19
7.4 CALIBRATION OF THE WIND DIRECTION FUNCTION	19
7.5 ADJUSTMENT OF THE ANALOG INDICATOR ON THE WIND MULTIFUNCTION.....	20
7.6 SETTING THE OFFSET ON THE DEPTH SENSOR.....	20
7.7 CALIBRATING THE COMPASS	20
8. INSTALLATION.....	22
8.1 SPEED/LOG SENSOR.....	22
8.2 DEPTH SENSOR.....	22
8.3 THRU-HULL FITTINGS.....	23
8.4 INSTALLATION OF THE LOG/SPEED AND DEPTH SENSORS	23

8.5	LOG/DEPTH JUNCTION BOX.....	24
8.6	WIND SPEED/DIRECTION SENSOR – MASTHEAD UNIT.....	24
8.7	INSTALLATION OF THE FLUXGATE COMPASS.....	25
8.8	INSTALLATION OF A MULTIFUNCTION.....	26
8.9	MAXI AND HYPER TOPLINE.....	27
8.10	REMOTE CONTROL FOR MULTIFUNCTIONS.....	28
9.	WIRING INSTRUCTIONS.....	28
9.1	INTRODUCTION.....	28
9.2	THE BUS CABLE.....	28
9.3	CONNECTION OF THE SENSORS AND DISPLAYS.....	29
9.4	CONNECTION TO THE SHIP’S POWER.....	30
10.	EXAMPLE OF INSTALLATION.....	31
11.	FIRST INITIALISATION OF THE BUS.....	32
11.1	ARCHITECTURE.....	32
11.2	NUMBERING OF THE DISPLAYS.....	32
11.3	RE-INITIALISING THE SYSTEM :.....	33
11.4	TOPLINE DISPLAYS ERROR MESSAGES.....	34

1. INTRODUCTION

The TOPLINE BUS is a complete electronic network, based on a single cable between the sensors, the displays, and the autopilot.

The different parameters and the alarms settings are stored in the sensors (active sensors). This enable every repeater or multifunction display to read and display the values available on the BUS.

In its simplest configuration, a BUS can be composed of only one multifunction display and a sensor. To complete the BUS, you only need to wire additional sensors or displays on the BUS, they will be automatically be added to the network.

For the installation, read sections 6, 7 and 8.

If the installation is already done, check the sensors installation and calibration and go to section 5.

2. COMMON CHARACTERISTICS OF THE SIMPLE, DOUBLE AND WIND MULTIFUNCTIONS

The simple, double and wind multifunctions give access to all the main channels and secondary channels available on the BUS.

2.1 MAIN CHANNELS – USED TO SELECT DATA FOR DISPLAY

2.1.1 Access

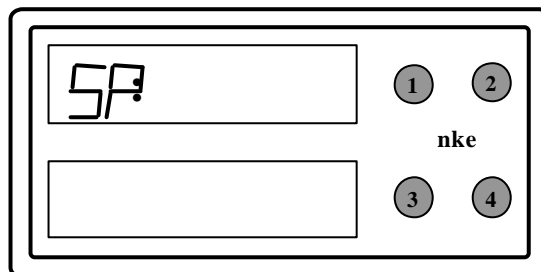

The access to the different channels is only possible if the relevant sensors are connected on the BUS.

- By pressing on the button 1, the top display shows the previous channel in the list.
- By pressing on the button 2, the top display shows the next channel in the list.
- By pressing on the button 3, the bottom display shows the precedent channel in the list.
- The button 4 is used for the Lighting Control, see in section 2.4.

2.2 SECONDARY CHANNELS – USED TO CONFIGURE AND CALIBRATE THE SYSTEM

2.2.1 Description of the different secondary channels

? **CALIBRATION (CA)**

Used to enter a correction coefficient (ie : log calibration : CA = 1.1, the displayed boat speed was 10% below the actual value)

? **OFFSET (OF)**

Used to deduct or to add a value to correct the value displayed. This parameter is used for the depth sounder, the log/speed sensor, the wind vane, the compass, the rudder reference.

? **FILTERING ((FI)**

This enables you to choose the dampening coefficient from 1 to 32. The default setting is at 8. This coefficient determines the frequency of refreshment of the data displayed, avoiding the too frequent value changes making the reading difficult. The smaller the value setted is, the more frequently the data is refreshed.

? **UNITS (UN)**

Used to the unit for the different sensors :

- In Knots (Kt) or Kilometers per Hour (K/H) for the log/speedo
- In Knots (Kt) or meters per second (M/S) for the anemometer
- In FAHRENHEIT degrees (°F) or CELSIUS degrees (°C) for the temperature
- In Meters (M) or Feet (Ft) for the Depth.

? **ALARMS** : There are 2 types of alarms :

† The ALARM Mode with a top and a bottom limit

HIGH ALARM (HA)

Is triggered when the value becomes superior to the value that you have set in the secondary channel HA.

LOW ALARM (LA)

Is triggered when the value becomes inferior to the value that you have set in the secondary channel LA.

The ALARM Mode with an angular value :

ALARM BASE (bA)

This the base angle determined for the alarm. E.g. Compass heading, wind angle

ALARM FORK (FO)

This is the authorised variation around the base angle. E.g. Compass Base angle set at 200, with an authorised variation set at +/- 5°, the fork value is set at 5.

2.2.2 Accessing the secondary channels

- By pressing on the buttons 1 or 2, bring the channel you want to enter on the top display.
- Press and hold the button 2, press on the button 1, the display alternatively shows the channel identification and the first secondary channel (ie SP->HA ->SP...)
- Press on the button 1 until you reach the secondary channel that you want to modify.
- Loose the button 2.
- By pressing on the buttons 1 or 2, bring the channel to the desired setting : - use the button 1 to decrease the value, the button 2 to increase it.
- Confirm your setting by pressing at the same time on the buttons 1 and 2.

Example :

You want to set an High Alarm on the speed sensor at 12 knots

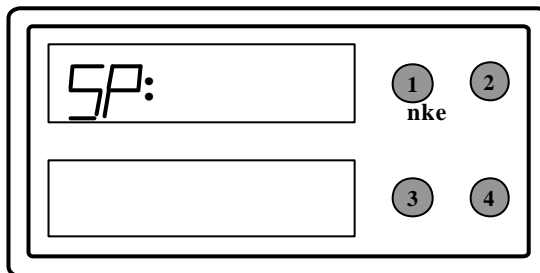

- By pressing on the buttons 1 or 2, bring the channel SP on the top display.
- Press and hold the button 2, press on the button 1, the display alternatively shows the channel identification and the first secondary channel (ie SP->HA ->SP...)
- Loose the button 2. The display shows **AH / SP : XX . XX** (XX . XX being the old High Alarm setting)
- By pressing on the buttons 1 or 2, bring the channel to the desired setting : - use the button 1 to decrease the value, the button 2 to increase it. To quickly modify the value, press the button 1 or 2 for more than 3 seconds.
- When you have the value 12.00, confirm your setting by pressing at the same time on the buttons 1 and 2.

Note :

- If you want to abandon the procedure, do not press any button for 5 seconds. The display will automatically exit the secondary channel.

2.3 SELECTING THE LANGUAGE

The user can choose between two languages, French or English. The factory setting is French.

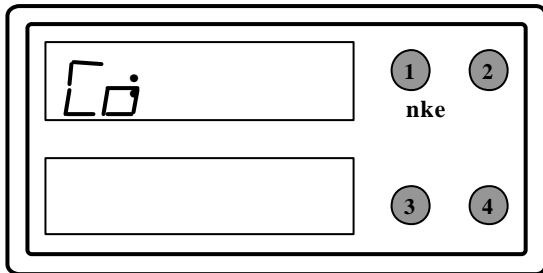

Use keys 1 & 2 to select channel **Co** on the top display. Press and hold the button 2.

Simultaneously, press button 1, the display then shows **Co / UA**.

Press again the button 1, the display then shows **Co / LA**.

Loose the button 2 and press it again to obtain :

Co / LA : Fran (for French)

Co / LA : Engl (for English)

To confirm your selection, press at the same time the button 1 and 2.

2.4 LIGHTING

Every multifunction can control its own lighting level or the general lighting level of the BUS multifunctions.

2.4.1 Global Lighting Control

The following operations act on all the displays.

1. Press the button 4 until the beep, and hold.
2. Press on the button 3 to select the light level (there is 4 levels of lighting).
3. Loose the button 4.
4. Press button 4 one more time

2.4.2 Local Lighting Control

The following operations act only on the display you are manipulating.

1. Press the button 4 until the beep, and hold.
2. Press on the button 1 to select the light level (there is 4 levels of lighting).
3. Loose the button 4

Note :

Any general setting automatically cancels a local setting.

2.5 ALARMS

Note – alarms settings are stored in the relevant transducers, and are therefore global settings

The alarms can be tuned and triggered from any multifunction of the BUS.

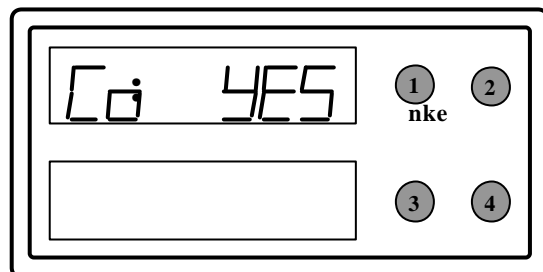
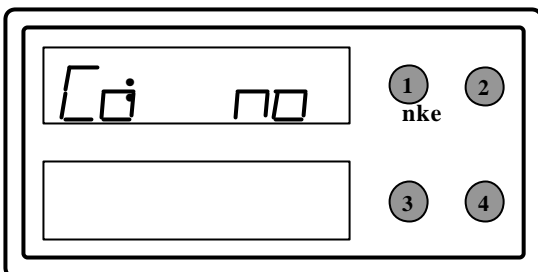

1. Bring the channel **Co** on the top display..
2. Press and hold the button 2.
3. Press the button 1, the display then shows **Co / UA no**.
4. Loose the button 2.
5. Loose the button 2 and press it again to obtain

Co / UA : yes † ALARMS ACTIVATED

Co / UA : no † ALARMS DE-ACTIVATED

6. To confirm your selection, press at the same time the buttons 1 and 2.

2.5.1 Triggering of an alarm

When an alarm is triggered, the top display of a multifunction automatically display the channel concerned, alternating between the channel name and the message ALARM. The buzzers ring.

2.5.2 Suspending an alarm

To switch off temporarily the alarm, you can press on the buttons 1 or 2.

The alarms are then suspended for 10 minutes. They will start again unless you have :

- de-activated the alarms in the channel Co.
- changed the alarm setting.

Or if the reason of the alarm has disappeared.

When the conditions to trigger an alarm have disappeared, the buzzers stops ringing but the displays still show the alarm message on the top display. To come back to a normal display, you just need to press the buttons 1 or 2.

3. WIND MULTIFUNCTION DISPLAY TOPLINE

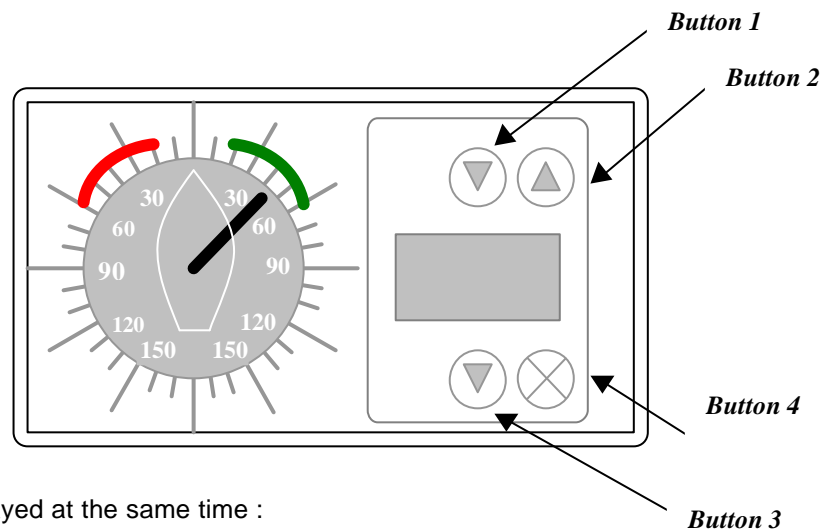

2 informations are displayed at the same time :

? **Analog Information :**

The apparent wind angle is constantly displayed (if the sensor is connected on the BUS).

The wind vane channel (Apparent Wind Angle : **Ad**) give access to the following **specific secondary channels** :

- ? Analog filter **AF** : this setting permits to select a dampening period to stabilize the indicator.
- ? Calibration **AO** : enable to adjust the needle position by entering an offset.

? **Digital Information :**

All the BUS parameters can be visualized on the 4 digits. The channel identification (ie SP, dE, etc) appears when changing the channel.

All the other functions can be done in the same way than on the simple and double multifunctions.
See section 2.

4. TOPLINE CHANNELS

SPEEDO.....	SP
TRIP LOG.....	TL
TOTAL LOG.....	LC
DEPTH.....	DE
APPARENT WIND SPEED.....	AS
APPARENT WND ANGLE.....	Ad
COMPASS HEADING.....	CO
RACE TIMER.....	CH
DEAD RECKONING.....	ri
TRUE WIND SPEED.....	TS
TRUE WIND ANGLE.....	EA
TRUE WIND DIRECTION.....	Ed
V.M.G.....	UC
C.M.G.....	CG
AIR TEMPERATURE.....	At
SEA TEMPERATURE.....	St
BATTERY VOLTAGE	bA
ENGINE HOURS.....	En
CONFIGURATION CHANNEL.....	Co

These different channels are only available if the relevant sensors are connected on the Bus.

4.1 SPEEDO

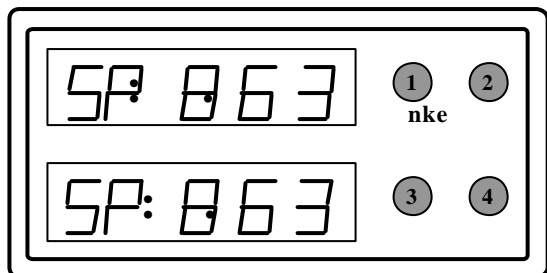

Requires the Log/Depth junction box and the speed/log sensor
The Boat Speed is displayed in Knots or in Km/h.

SECONDARY CHANNELS ACCESSIBLE :
HA, LA, FI, rA, OF, Un

4.2 TRIP LOG

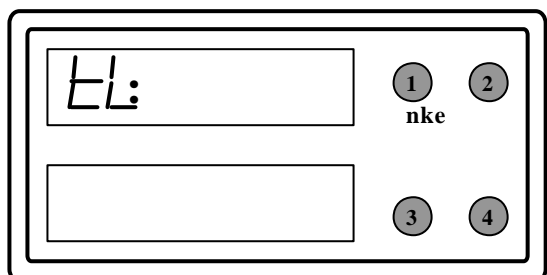

Requires the Log/Depth junction box and the speed/log sensor.
The trip log is displayed in kilometers or nautical/miles according to the speedo unit.

Resetting the trip log to 0 (on all the Topline multifunctions, including the Performance multifunction and the TL25)

- ? Bring the channel tL or Trip Log on the top display
- ? Press the button 1 (bottom arrow) for 5 seconds (approx) until the BEEP.
- ? You can loose the button, the trip log is resetted to 0.

4.3 LOG GENERAL

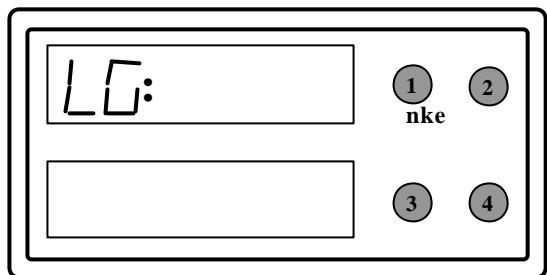

The trip log is displayed in kilometers or nautical/miles according to the speedo unit.

4.4 WINDSPEED

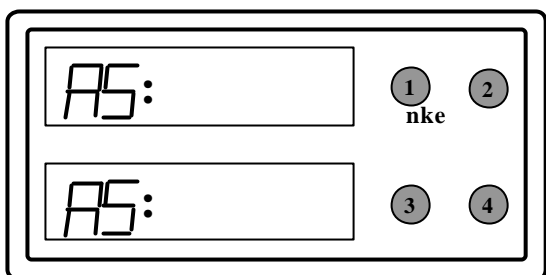

Requires the windspeed or complete mast-head unit sensor
The windspeed is displayed in knots or meters/second

SECONDARY CHANNELS ACCESSIBLE :
HA, LA, FI, rA, OF, Un

4.5 APPARENT WIND ANGLE

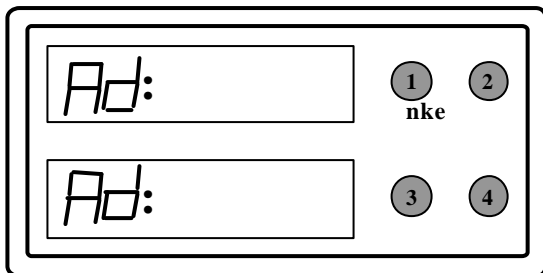

Requires the complete mast-head unit sensor

125° Starboard is displayed as **125** –
125° Port is displayed as **– 125**

SECONDARY CHANNELS ACCESSIBLES :
Ba, FO, FI, OF

4.6 COMPASS

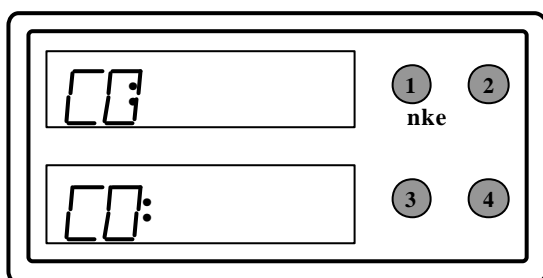

Requires the compass sensor

SECONDARY CHANNELS ACCESSIBLES :
Ba, FO, FI, OF

4.7 RACE TIMER

Requires any kind of multifunction

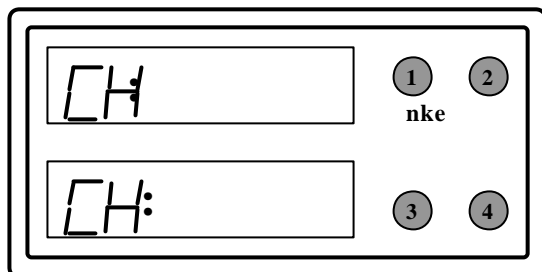

With the buttons 1 and 2, bring the channel **CH** on the top display.

Press the button 1 for three seconds and loose it.

The top display becomes **CH** and then **10 : 00**

Press on the button 2

The top display begins the countdown from **10 : 00**

If you want to bring the countdown to 5 minutes, press the button 2 again. The top display shortens the countdown by bringing it to 5 minutes.

At 5 seconds from the end, the multifunction beeps every second.

If you want to stop the race timer and reset it to 10 mn, press the button 1 for 3 seconds and loose it.

When the countdown is finished, the race timer begins to count the racing time.

4.8 DEAD RECKONING

Displayed as r1 and r2

Sensor necessary : Speed/log transducer, Compas

Dead reckoning can be displayed on :

Single multifunction display

Double multifunction display

- top window

Combining information from the fluxgate compass and the log sensor, the TOPLINE system calculates the ship's dead reckoning. This information is displayed as course and distance covered. The display window alternates between displaying these two values.

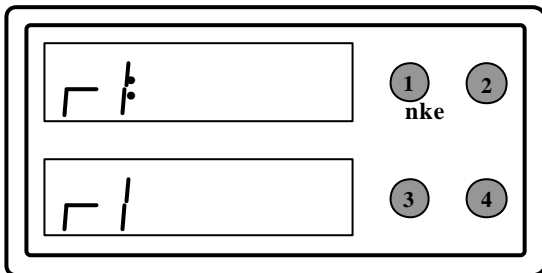

Procedure to start dead reckoning calculations

- 1- Using the buttons 1 and 2, set the display on "r1"
- 2- Press the button 1 until you hear a beep.
- 3- This begins the dead reckoning calculations and automatically resets r1 to zero.
The display will now alternate between showing course and distance covered from the point where the procedure was started.
- 4- Previous dead reckoning information is automatically transferred from "r1" to the second dead reckoning channel, "r2". In other words, the "r2" dead reckoning channel is the memory channel for previous "r1" information.

4.9 TRUE WIND SPEED

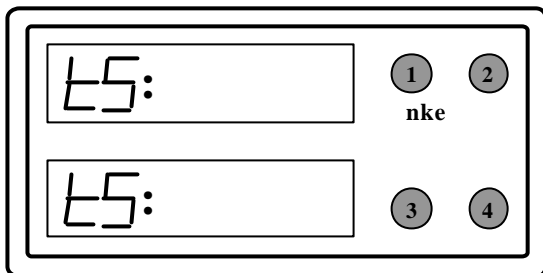

Requires the mast-head unit and speedo sensors

SECONDARY CHANNELS ACCESSIBLE :
HA, LA

4.10 TRUE WIND ANGLE

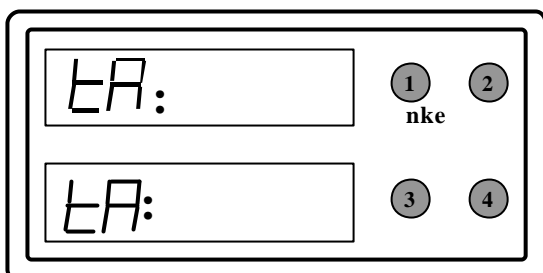

Requires the mast-head unit and speedo sensors

125° Starboard is displayed as **125 –**
125° Port is displayed as **– 125**

SECONDARY CHANNELS ACCESSIBLES :
Ba, FO

4.11 TRUE WIND DIRECTION

Requires the mast-head unit, the compass and speedo sensors

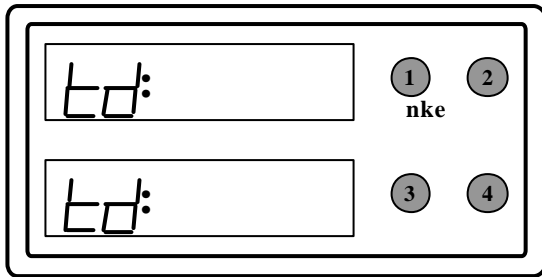

Gives the wind direction related to the magnetic North

4.12 VMG (VELOCITY MADE GOOD)

Requires the log/speed sensor and the mast-head unit
Displayed as : UG

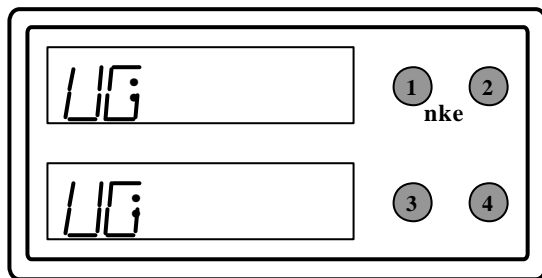

VMG can be displayed on :
Single multifunction display
Double multifunction display
- top window

VMG represents the velocity made good (in knots) of the boat in the direction of the wind.

VMG is calculated from a function of the boat's speed and the angle between the boat's heading and the direction of the wind.

4.13 VMC (Course Made Good)

Requires the Speed/Log, Masthead unit and Compass sensors

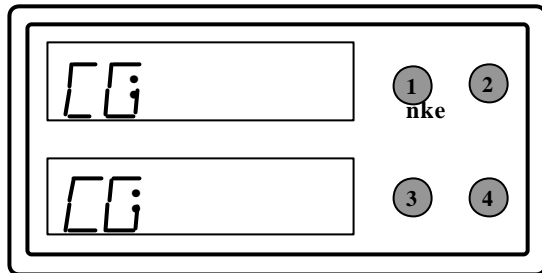

VMC can be displayed on:
Single multifunction display
Double multifunction display
- top window

VMC represents the velocity made good (in knots) of the boat in the direction of a mark (instead of the direction of the wind as with VMG).

The course to the mark is entered into memory at the secondary channel "BASE ANGLE" at any Single or Double Multi-Function Display.

The course (Base Angle) to the mark is entered as follows :

- 1- Using button 1 and button 2, set the top display on "CG"
- Push button1 until the display alternates between showing "CG : XXXX" and "BA : XXXX" (the XXXX represents blank number locations).
- 2- Release both keys.
- 3- By holding down button 1 (+3 secs.) you quickly decrease the value displayed.
- 4- By holding down button 2 (+3 secs.) you quickly increase the value displayed.
- 5- By pushing button1 ou decrease the value displayed step by step.
- 6- By pushing button 2 you increase the value displayed step by step.
- 7- Enter the heading to the mark in decrease.
- 8- Push button 1 and button 2 simultaneously until the beep.
- 9- The display comes back to the main channel.

4.14 AIR TEMPERATURE

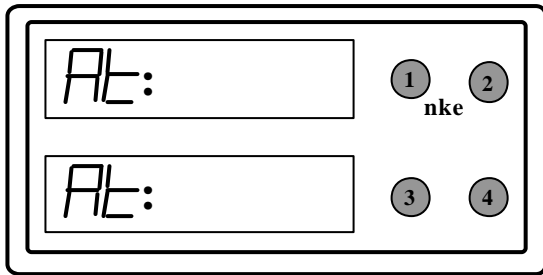

Requires the mast-head unit or the windspeed sensor

SECONDARY CHANNELS ACCESSIBLE :
HA, LA, Un, OF

4.15 SEA TEMPERATURE

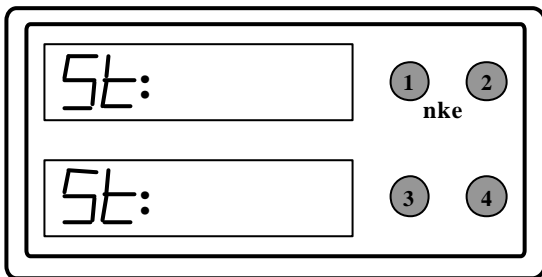

Requires the log/speedo sensor

SECONDARY CHANNELS ACCESSIBLE :
HA, LA, Un, OF

4.16 BATTERY VOLTAGE

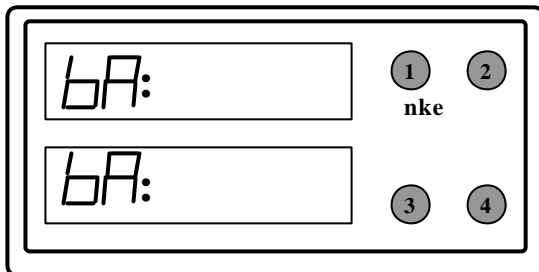

Requires the log/depth junction box.

SECONDARY CHANNELS ACCESSIBLE :
HA, LA

Note : If the battery voltage fell under 10.5 volts, the complete system is locked :
The different informations are stored (calibration, total log, dead reckoning, ...)

- the top display shows **default**
- the bottom display shows **batt**

5. TOPLINE MULTIFUNCTIONS REMOTE CONTROL (TYPE BEFORE MID-2001)

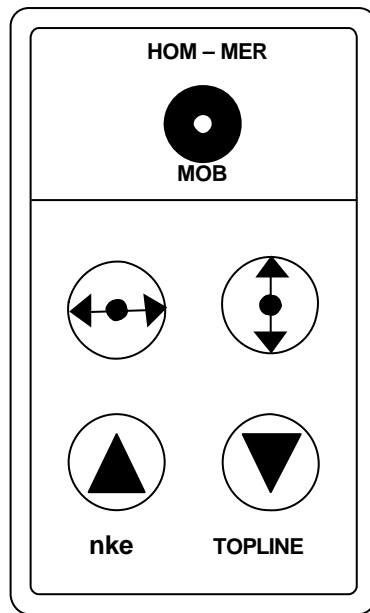

5.1 UTILISATION

Button “HOM – MER” or “MOB”



A 2 seconds pressure on the MOB button activates the MOB procedure. To cancel a MOB procedure, the system must be switched off.

? Button

Enables you to switch from one display to another. The channels begin to flash to signal that this is the display which is controlled by the remote.

? Button

Enables you to switch from one line of a display to another.

? Buttons and

These buttons enable you to change the channel displayed.

5.2 LIGHTING

note : hyper and maxi displays can only be adjusted on bus global lighting settings

1. With the button , bring the flashing line on the bottom display of a multifunction,

2. Press the button and maintain,

After 2 seconds, while maintaining the button maintained,

push on the until the lights are at the level wished,

3. Loose the button.

5.3 TRIGGERING THE RACE TIMER FROM THE REMOTE CONTROL

1. With the buttons 1  and 2  , bring the top display on the channel **CH**.

2. Press the button 2  for three seconds and loose it.

The top display becomes **CH** and then **10 : 00**

3. Press on the button 1 

The top display becomes **CH** and then begins the countdown from **10 : 00**

4. If you want to bring the countdown to 5 minutes, press the button 1 

5. The top display becomes **CH** and shortens the countdown by bringing it at 5 minutes.

6. If you want to stop the race timer and reset it to 10 mn, press the button 2  for 3 seconds and loose it.

When the countdown is finished, the race timer begins to count the racing time. (in hours and minutes)

6. REMOTE CONTROL FOR MULTIFUNCTIONS (SINCE MID-2001)

6.1 PRESENTATION

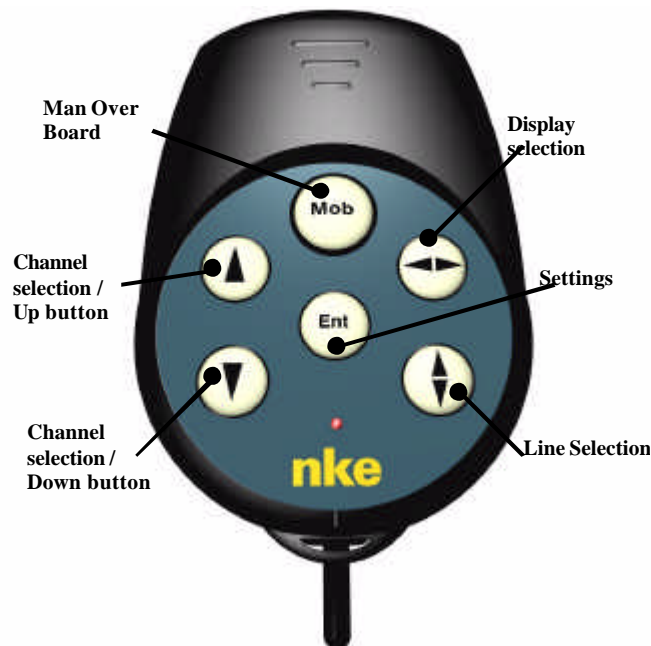

This watertight remote control enables you to choose the data to display on all the board multifunctions.

It also gives access to :

? **lighting level tuning and race timer functions for all the Topline multifunctions**

(MS 13 – MD 13 – MD 18 – Performance – Triple 25 – MS 40 and TL25)

? **all the functions of the TL25 multifunction display.**

6.2 OPERATION

6.2.1 PRIMARY FUNCTIONS

? **Mob button** 

A 5 seconds pressure on this button triggers the Man Over Board procedure. All the board multifunctions will then display the Man Over Board channel, giving :

With a Topline GPS connected : heading and distance to the Man Over Board

With a log/speedo and compass connected : a dead-reckoning calculation

Caution : the dead-reckoning function doesn't take into account the drift of the boat due to wind and tide.

To cancel a MOB procedure, the system must be switched off.

? **Button** 

Enables you to switch from one display to another. The channels begin to flash to signal that this is the display that is controlled by the remote.

? **Button** 

Enables you to switch from one line of a display to another.

? **Buttons**  **and** 

These buttons enable you to change the channel displayed or adjust the secondary channels values.



NOTE: If you wish to use the remote control for only one display, you can just stop using the button  once you have selected the desired display.

6.2.2 TUNING THE LIGHTING LEVEL

? **ON THE FOLLOWING DISPLAY TYPES (MS 13 – MD 13 – MD 18 – PERFORMANCE – TRIPLE 25 – MS 40)**

1. Using the button  , select the bottom line of the displays.

2. Press and hold the button 

After 2 seconds, while maintaining the  pressed, use the button  to select the desired lighting level.



3. Loose the button .

? **On the TL 25 multifunction**

Refer to the TL25 user guide

6.2.3 TRIGGERING THE RACE TIMER FROM THE REMOTE CONTROL



? **ON THE FOLLOWING DISPLAY TYPES (MS 13 – MD 13 – MD 18 – PERFORMANCE – TRIPLE 25 – MS 40)**

1. With the buttons  and  , bring the top display on the channel **CH**.
2. Press the button  for three seconds and loose it.

The top display becomes **CH** and then **10 : 00**

3. Press on the button 

The top display becomes **CH** and then begins the countdown from **10 : 00**

4. If you want to bring the countdown to 5 minutes, press the button 
5. The top display becomes **CH** and shortens the countdown by bringing it at 5 minutes.
6. If you want to stop the race timer and reset it to 10 min, press the button  for 3 seconds and loose it.

When the countdown is finished, the race timer begins to count the racing time. (in hours and minutes)

? **On the TL25 multifunction**

Refer to the TL25 user guide

6.2.4 ACCESS TO THE TL25'S SECONDARY CHANNELS

Refer to the TL25 user guide

7. SETTING UP THE SYSTEM FOR USE

Several procedures need to be completed in order to get accurate information from your TOPLINE system.

7.1 ADJUSTING THE ELECTROMAGNETIC SPEEDO

This section is only for systems that use the electromagnetic speedo for the speed/log functions.

When your TOPLINE system is first installed, the speed function may indicate a speed value even when the boat is not moving (ie **0.58**). This value must be reset to zero to make the speed and log function :

- 1- Using the button 1 or the button 2, put the display on the speed channel, "SP".
- 2- Make note of the value that is displayed on the speed channel.
- 3- Access the Offset secondary channel (OF) as per instructions in section 2.2.2.
- 4- Enter the negative value (- **0.58**) on the speed channel.
- 5- Push both buttons 1 and 2 simultaneously until you hear a beep.
This enters the value in memory.

REMEMBER !

The Electromagnetic speedo must be installed facing forward.
This can be determined by making sure that the small plastic nob on top of the sensor is facing forward.

NOTE :

If the speed value is different on opposite tacks, the speedo needs to be rotated slightly in the thru-hull fitting.

7.2 CALIBRATION OF THE SPEED / LOG FUNCTION

This procedure requires using a known measured distance between two points. For best results, use a “measured mile range”.

It should be carried out under the following conditions :

On smooth water

With little or no wind

At a constant speed under engine

At slack tide

Procedure for calibrating the speed /log function :

- 1- Using the button 1 or The button 2
- 2- Reset the TRIP LOG to zero according to the procedure under “TRIP LOG” section 5.3.1.
- 3- Sail back and forth between the two fixed points.
- 4- Record the distance on the trip log.
- 5- Make the necessary calculations to determine the “Percentage Correction Factor” (known distance divided into trip log distance) – see below.
- 6- Using the button 1 or the button 2, put the display on the SPEED channel, designated by “SP”.
- 7- Access the secondary channel for calibration, “rA”, according to section 6.9.
- 8- The display will now show the previously entered correction factor, or “01.00”, which indicates that there is no correction factor in the system *.
- 9- Use the button 1 or the button 2 to set the new correction factor :
By pushing the button 1 you decrease the value displayed step by step.
By pushing the button 2 you increase the value displayed step by step.
- 10- By pressing the button1 and the button2 simultaneously, the new value is entered and stored in memory.

* Before sailing the measured distance to perform a calibration procedure, you must reset the correction factor to “01.00”.

CALIBRATION EXAMPLE

The known measured distance is : 2,46 Miles

The distance travelled according to the trip log is : 1,88 Miles

Divide the known measured distance by the distance travelled : $2,46 / 1,88 = 1,31$.

This is the new correction factor.

Enter the correction factor as "01.31" into the system according to the procedure in section 7.1 as above.

7.3 CALIBRATION OF THE WIND SPEED FUNCTION

The wind speed calibration factor is set in factory. If you want to modify it, follow the procedure hereafter :

Calibrate the Wind Speed Function under the following conditions :

With no wind, at slack tide, on smooth water, at a constant speed under power

IMPORTANT !

This procedure can only be carried out successfully if the calibration of the boat speed function has been completed.

Procedure for calibrating the wind speed function :

- 1- Using the buttons 1 and 2, put one display window on boat speed, "SP", and one display window on apparent wind speed, "AS".
- 2- Power the boat at a constant speed and make note of both the boat speed and the indicated wind speed.
- 3- Calculate the percentage difference between the two values to get your correction factor.

Example : Boat speed = 6 knots

Wind speed = 5 knots

20 % difference between values

enter 1.20 for correction factor.

- 4- Enter this value in the calibration secondary channel, "rA", of the apparent wind speed function, "AS" as per the instruction in section 2.2.2.

7.4 CALIBRATION OF THE WIND DIRECTION FUNCTION

This procedure can be useful in case of a bad alignment of the mast-head regarding the boat's axis.

A Topline mast-head unit is designed to be mounted with the arm directed to the front of the boat. An offset is entered (between - 180 and + 180) in the sensor to set the zero with the counterweight in front.

7.4.1 Procedure

The boat is considered to be perfectly tuned.

1. Using the buttons 1 and 2, put one display window on boat speed, "Ad"
2. Tack several times and write down the values displayed on the channel "Ad"
3. Calculate the average wind angle on each tack

ie : Tacks on Starboard : **Average angle => 38-**

Tacks on Port : **Average angle => -42**

4. The value to add or withdraw to the OF channel is half the difference between the Starboard and Port tacks.

ie : $38 - 42 = -4 / 2 = -2$

If the factory setting was 60, you should now enter $60 - 2 = 58$.

(See section 2.2.2 Accessing the secondary channel.)

7.5 ADJUSTMENT OF THE ANALOG INDICATOR ON THE WIND MULTIFUNCTION

This adjustment has to be done only after the wind direction calibration is completed.

1. Using the buttons 1 and 2, put one display window on Apparent Wind Angle, “**Ad**”.
2. Press and hold the button 2, press on the button 1 until you reach the secondary channel **AO**.
3. Loose the button 2.
4. Using the buttons 1 or 2, add or withdraw an offset to bring the needle on the same value than the digital value (the one given by the sensor)
5. By pressing the button1 and the button2 simultaneously, the new value is entered and stored in memory.

7.6 SETTING THE OFFSET ON THE DEPTH SENSOR

The offset on the depth channel will allow you to set the depth to read below the keel or from the water surface.

Procedure for setting an offset on the depth function

- 1- Using the buttons 1 or 2, put the display on the depth channel, “**dE**”.
- 2- Access the Offset, secondary channel as per instructions in section 2.2.2.
- 3- Enter the number of feet away from the depth sensor where you want the system to begin measuring from.
 - Add a positive value if the point is below the sensor. (e.g. Keel)
 - Add a negative value if the point is above the sensor. (e.g. Water Surface).
- 4- Push both the buttons 1 and 2 simultaneously until you hear a beep.
This enters the value in memory.

7.7 CALIBRATING THE COMPASS

Note : First, make sure you have the following conditions :

- All the boat's equipment is stored in its usual location
- No current
- Flat seas
- No wind
- Away from magnetic fields (for example, large ships).

7.7.1 Adjustment

- Switch on the installation
- Put a multifunction on the CO channel (Compass)
- Direct the boat on the magnetic North
- Unscrew the bolt at the top of the sensor
- Swing the compass to bring the displayed heading to the North
- Tighten the bolt to block the sensor in position

To receive the most accurate information from the fluxgate compass, the compass must be initialized for deviation.

7.7.2 Swinging the compass

1. Begin moving your boat at a constant 2-3 knots in a clockwise circle that is about 4-5 times the size (in radius) of your boat.
2. Push the initialisation button

- *Single, Double or Wind multifunction display : With the top window on CO, push the button n°3 (lower left key) until you hear a beep.*

Note : As soon as the compensation procedure starts and the circle begins, the Compass windows in the Toplevel system will alternate between displaying compass heading* (CO : 325°), and the number of circles and the difference with the preceding circle ((CO:3002, eg. 3 rd circle, 2° difference)

At least two circles are necessary :

Circle n°0 : between the mode start and the first time the boat points North.

Circle n°1 : following circle necessary to measure the circle time

Circle n°2 : compass table up-date

Following circles compass table up-date, if important differences are measured from one circle to another, the system automatically goes out of the compensation mode. You then need to re-start the procedure.

From the circle n°3, you can store whenever you want the calculated data by going out of the compensation mode :

To exit the procedure : press the button n°3 for 8 seconds until you hear a BIP

The compass function has now been compensated for deviation, and will store this compensation in memory.

Check the accuracy of the fluxgate against your fluid compass on all quadrants. Remember, fluid compasses usually have a deviation chart that will tell you the correct readings of the fluid compass. This should be used when checking the quadrants.

If the readings on the fluxgate are not correct, the procedure will have to be performed again. This procedures may require some patience. Sometimes, this procedure has to be performed more than once before an accurate reading is displayed. Each additional attempt should be made under slightly different circling conditions : Different boat speed or different circle sizes.

7.7.3 Manual compensation

Make a note of the value to the right or left of North that the Compass displays when the boat is pointed to due North (Mag.).

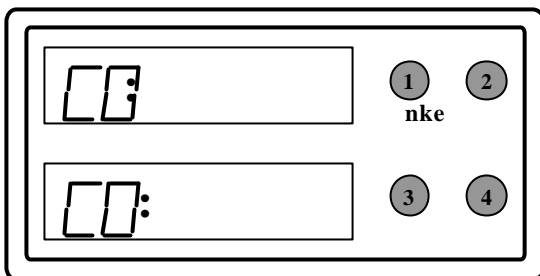

1. Using button 1 and button 2, set the top display on "CO"
- 6- Access the Offset secondary channel (OF) as per instructions in section 2.2.2.
- 7- Enter the correcting value in the Of channel with the buttons 1 and 2.
- 8- Push both buttons 1 and 2 simultaneously until you hear a beep.
This enters the value in memory.

8. INSTALLATION

8.1 SPEED/LOG SENSOR

The Paddlewheel or Electromagnetic sensors are connected on the Log/Depth junction box. They are supplied with a 3 meters cable.

8.1.1 Location

The sensor must be :

- As close as possible to the boat's axis
- Always immersed
- In an area where there is no turbulence (especially for the electromagnetic log)
- Away from areas of electrical interference
- Accessible for cleaning from the inside of the boat
- Retractable, thereby not obstructed by floorboards

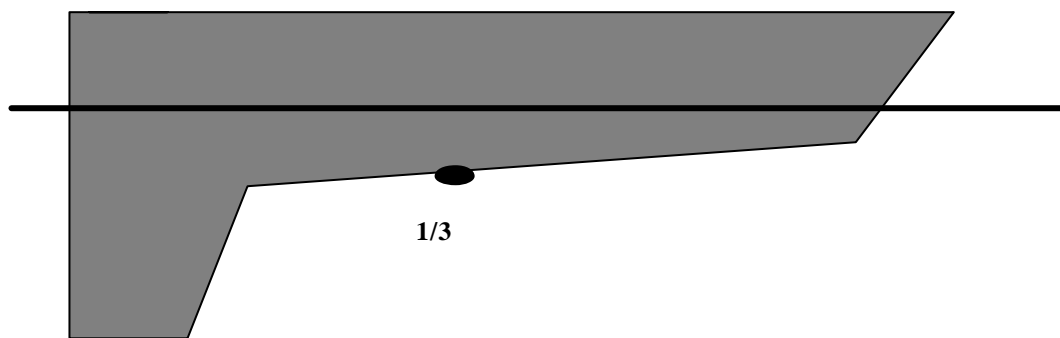

On a sailing boat : the ideal position is in front of the keel in the boat axis (approx 50 cm).

On a motor boat : approximately at 50 cm behind the immersion limit of the boat. For an EM log, it can be necessary to add a shaped fairing block of 10 to 15 mm to make sure that the electrodes are out of the turbulent water.

8.2 DEPTH SENSOR

The Depth sensors are connected on the Log/Depth junction box. He is are supplied with a 3 meters cable.

8.2.1 Location

Take the same considerations than for the log sensor to install the thru-hull fitting. And also bear in mind :

- Installed as vertically as possible, not more than 10° off vertical
- Sufficiently away from the keel to avoid receiving a false echo signal of the keel (the sensor transmits a cone of approximately 30°)

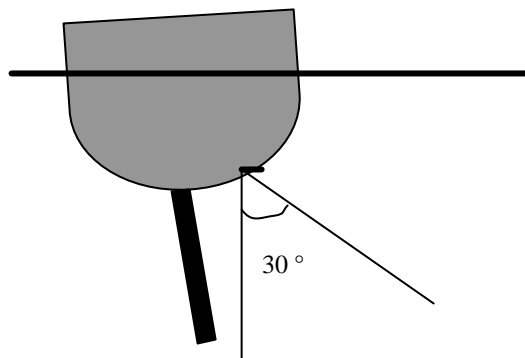

NOTE :

- Must not be installed behind the keel to avoid turbulences.

8.3 THRU-HULL FITTINGS

8.3.1 Mounting

Once the position for the sensors are established, use the following procedure to install the thru-hull fittings in the hull of your boat: :

1. Drill a pilot hole from the inside out.
2. From the outside, drill a 51 mm hole.
3. Clean all surfaces of the hole and the thru-hull fitting.
4. Take the cap and nut off.
5. Put sealant (e.g. 3M 5200) on the collar.
6. Fit the thru-hull fitting in the hole.
7. Put sealant on the inside of the boat around the thru-hull fitting.
8. Screw on the nut and hand tighten firmly.
9. Screw the cap on the thru-hull fitting.
10. Let dry for sealant manufacturer's recommended drying time.

*On boats with inner-skin (pan), you will have to drill an oversized hole of about 70 mm (in the inner-skin only!) to make room for the locking nut.

8.4 INSTALLATION OF THE LOG/SPEED AND DEPTH SENSORS

- When the sealant is dry on the thru-hull, push the sensor all the way down
- Tighten the nut (not too firmly)
- Orientate the handle parallel to the boat's axis.
- Make sure the stainless steel handle is correctly seated in the plastic notches.

8.4.1 Position of the Paddlewheel Log

- In the normal position, the sensor is pushed all the way down with the handle parallel to the boat's axis and is working at 2 cm from the hull, avoiding the water perturbations.
- If you retract the sensor in the axis, the paddlewheel comes flush to the hull, this can be used to avoid algae or dirt. This position should not be used permanently as the values are then false.
- By turning the handle of a quarter, you retract completely the sensor into the thru-hull fitting.

8.4.2 Position of the Electromagnetic Log

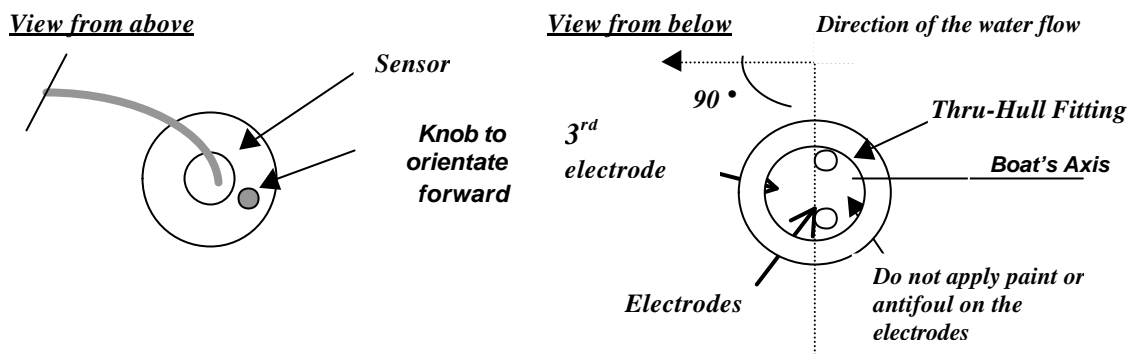

- The electromagnetic speed/log sensor must be correctly oriented in a fore/aft position. This position can be determined by orienting the small plastic knob on the top of the sensor in a forward facing position.
- In the normal position, the sensor is pushed all the way down and is exceeding the hull by two millimeters.
- Correct orientation is extremely important for accurate speed and log readings.

- By turning the handle of a quarter, you retract completely the sensor into the thru-hull fitting.

8.4.3 Position of the Depth sensor :

- In the normal position, the sensor is pushed all the way down and is flush to the hull.
- By turning the handle of a quarter, you retract completely the sensor into the thru-hull fitting.

8.4.4 Recommendations

- For the electro-magnetic log, you can **apply antifoul on the thru-hull fitting, but never on the active part of the transducer and the electrodes.**
- Always retract the sensors when taking the boat out of the water, to avoid a possible damage during the manipulation.
- The thru-hull fittings are delivered greased. To avoid having the sensors blocked in the thru-hull fittings, **grease them regularly** with a silicon grease.

8.5 LOG/DEPTH JUNCTION BOX

This junction box is used to connect the depth sensor and the speed/log sensor to the bus cable.

The 3 connection points on this junction box are for /

- Depth sensor
- Bus cable
- Speed/log Sensor

It should be placed in the forward section of the boat within 3 meters (the length of the sensors

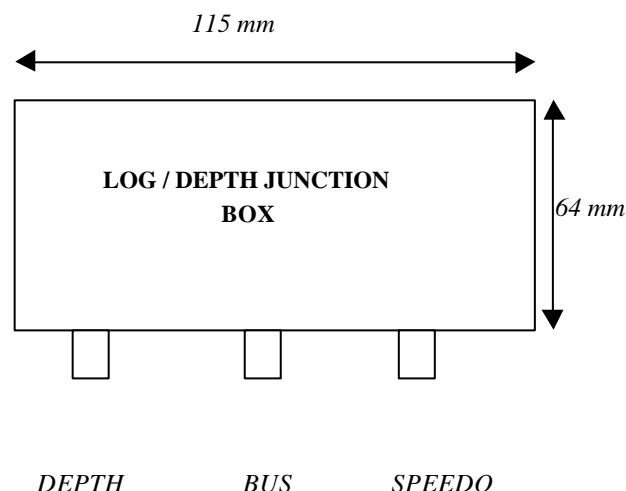

cables) of the depth and speed sensors, preferably in a locker or compartment where it will not get wet, or damaged from heavy equipment. The junction box is affixed with four self-adhesive strips.

8.6 WIND SPEED/DIRECTION SENSOR – MASTHEAD UNIT

The masthead unit should be mounted on the top of the mast away from possible contact with other mast-head equipment.

The masthead unit is designed to face forward. If you want to install it facing aft, you will have to enter a 180° offset.

8.6.1 Installation

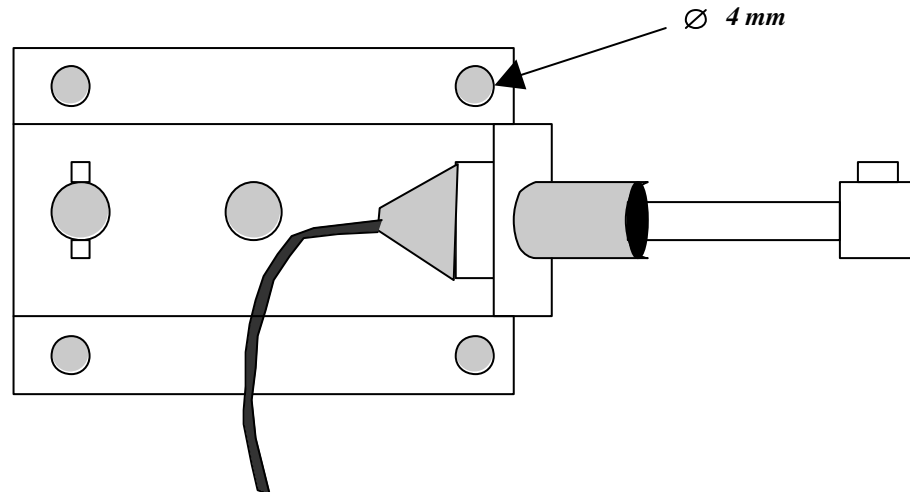

1. Align the masthead bracket with the axis of the boat.
2. Drill 4 holes for 4 mm selftapping screws or rivets.
3. Attach the bracket to the top of the mast with selftapping screws or rivets.
For fine alignment, loosen the two nuts in the middle of the secondary mounting plate, align the unit, then tighten the two nuts (use Loc-Tite when finished).
4. Feed the cable into the mast thru a chafe-free hole.
5. Secure the cable separately to the mast so that the weight of the cable is not being taken by the bracket.
6. Run the cable thru the inside of the mast, preferably in conduit, and exit the mast thru a chafe-free hole.
Make sure that no running rigging interferes with the cable on the inside of the mast !
7. A thru-deck fitting should be used to lead the cable thru the deck with deck step masts.
8. Put the junction box (supplied) inside the boat near the mast where the connection between the masthead unit and bus cable is made.
9. Cut the masthead cable at the junction box (keep a 1' loop spare).
10. Cut the bus cable, prepare all cables, and connect them in a junction box as per instructions on page 12, section 3.1.

8.6.2 Recommendations

Masthead units are FRAGILE and should never be hoisted on a halyard or wire, but placed securely in a bucket and then hoisted aloft.

Always remove the masthead unit first before unstepping or stepping your mast !

The mast-head bracket is designed to enable an easy mounting and dismantling. **When dismantling, do not forget to put the plug cap to avoid water entries.**

8.7 INSTALLATION OF THE FLUXGATE COMPASS

The compass must be positioned carefully,

- as close as possible to the boat's axes.
- at least one meter away of the magnetic compass.
- as far as possible from all the potential sources of the magnetic disturbances, at least one meter away from speakers, radio transmitters or receivers or other possibly magnetic items :

hi-fi equipment
 radar
 boat's engine
 battery generator and charger
 fridge
 electric engines

tool box
 anchor
 electric panels
 metallic casing for electric cables
 all portable electronic units
 etc

8.7.1 Location

With the above advice in mind, select a location for the compass, and check that there is no major electromagnetic disturbance with the following procedure :

- Put a manual compass at the chosen location and compare the value to the board compass. If the error is less than 10°, the location is probably suitable. Ideally, the best way to check would be to steer the boat in circle and check the suitability on 360°.

8.7.2 Mounting

- Position the square vertically and mount it with the two amagnetic screws
- Unscrew the nut at the top of the sensor and put the threaded rod in the square's notch
- Tighten lightly the nut
- Position the cable (still as far as possible from the magnetic sources) and wire it to the BUS with a junction box

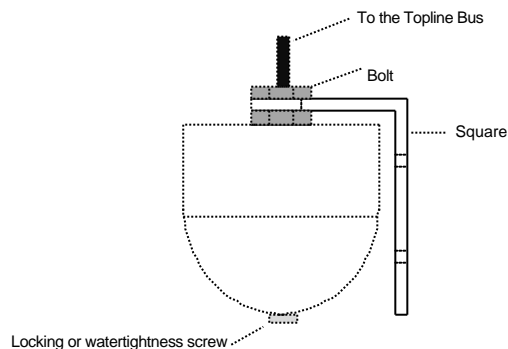

You'll tighten definitely the compass nut after the initialisation.

When the installation is completed, remove the long metal screw (used to block the cardan during transport) and replace it with the short NYLON screw supplied with the compass.

Note : On compasses produced after June 2001, there is no longer a blocking screw. Do not then remove the one in place.

8.8 INSTALLATION OF A MULTIFUNCTION

Perfectly watertight, it is wired on the BUS as all Topline sensors and displays.

Several considerations should be kept in mind when installing the display :

- Away (at least 20 centimeters) from magnetic compasses
- Away (at least 1 meter) from a radio receiver/transmitter
- Located for easy access and clear viewing.
- Installed in a location that is safe from excessive impact (spinnaker poles, winch handles, etc)

8.8.1 Installation procedure

- Drill a hole of 14 mm at the chosen location
- Remove the nut from the mounting stud on the back of the display
- Apply sealant to the back of the display around the threaded stud and around the edge of the back panel
- Feed the wire through the hole
- Mount the display
- Hand tighten the nut on the back of the display (**DO NOT OVER TIGHTEN THIS NUT**, it could break the stud and endanger the box watertightness !)
- Prepare the wires and connect them into the junction box.

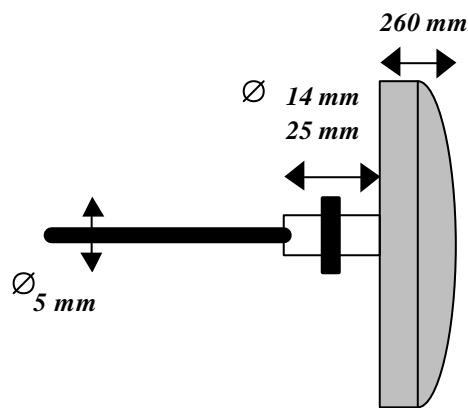

8.9 MAXI AND HYPER TOPLINE

The Maxi Topline or Hyper Topline displays are fully watertight and controlled by a remote control connected on the Bus and located anywhere in the boat.

8.9.1 Location

They are usually mounted on the mast (with specific mast-mount brackets available from nke) but they can also be mounted on any flat surface inside or outside the boat.

The display must be :

- Away (at least 20 centimeters) from magnetic compasses
- Away (at least 1 meter) from a radio receiver/transmitter
- Located for easy access and clear viewing for the Helmsman and the crew members
- Installed in a location that is safe from excessive impact (spinnaker poles, winch handles, etc)

8.9.2 Installation

With 4 screws at each corner of the display.

- Diameter 4 mm. **IMPORTANT** : Do not use a bigger diameter, you could damage the box and generate water entries in the box.
- Minimum length : 20 mm. Depending on the type of bracket you are using.

8.10 REMOTE CONTROL FOR MULTIFUNCTIONS

8.10.1 Location

Generally installed in the cockpit.

- Away (at least 20 centimeters) from magnetic compasses

8.10.2 Installation

Fix it with a double-sides tape on a flat surface

Wire it to the Bus as you would do with any normal multifunction.

9. WIRING INSTRUCTIONS

9.1 INTRODUCTION

Before beginning the installation, keep in mind that a good initial installation will enable you to avoid further problems. We then recommend to you to follow methodically the installation procedure.

To connect the elements together, always proceed as follows :

- All cables should be ran as far as possible of electric or electronic elements that could generate perturbations (ie : fridge, radio transmitter, important metal parts, etc)
- All cables and connections should be ran in safe and DRY locations.

Prepare all your tools and material before starting the installation :

† Soldering Iron	† Screw driver flat and cross
† Drill	† Rings to fix electrical wires
† Hacksaw	† A cutter
† Drills of diameter 4 – 15 mm	† Screws
† Sealant	† Rivets
† Silicon Grease	† Etc
† Flat keys	

9.2 THE BUS CABLE

All the elements of the Bus can be wired through a 3 wires cable, the Topline Bus. The Bus Cable is made of two shielded wires.

- the + 12 volts white wire and the data black cable)
- the bare wire : the 0 volts (-).

The connections can then be made easily by connecting together all the wires (in parallel), colour to colour. These connections must obviously be protected from the water and are therefore made in the junction boxes supplied.

9.3 CONNECTION OF THE SENSORS AND DISPLAYS

All the sensors and displays should be connected in Topline Bus connection boxes, apart from the log and depth sensors connected on the log/depth junction box.

1. Cut the Bus cable at the nearest point from the display or sensor.
2. Mount a junction box at this location
3. Strip 3 cm of the cover off the Bus cable.



4. Strip the wires of the two Bus cables and of the Display/Sensor Bus cable.



5. For good connections and prevent corrosion, apply silver solder on the tips of the wires.
6. Feed the three cables into the junction box.
7. Connect, colour to colour, the three wires of each cable to each other on the connectors
8. Apply wire ties to the cables on the inside of the junction box to prevent the cables from being pulled out accidentally.
9. Close the box.

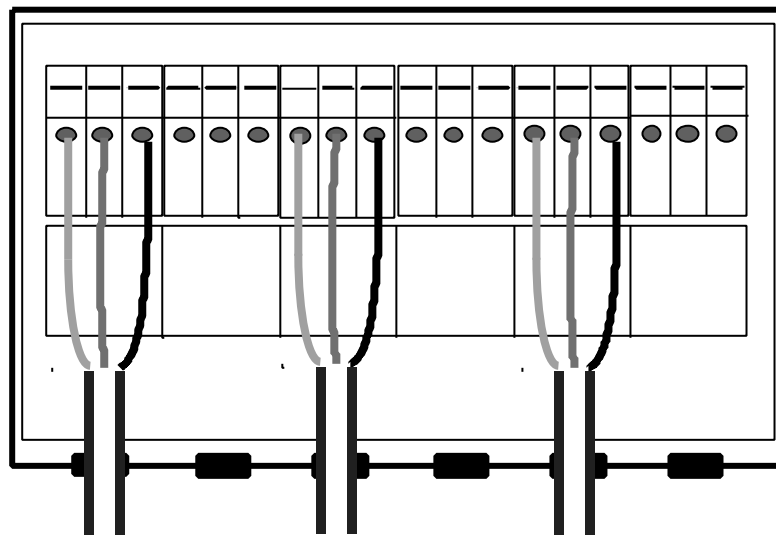

TOPLINE BUS CABLE

9.4 CONNECTION TO THE SHIP'S POWER

1. Cut the Bus where it runs closest to the main switchboard.
2. On the power cable going to the main switchboard, **at both ends**, cut the data (black) wire of 2 cm and tape or insulate the end so that no contact can be made with the other wires.
3. In the connection box, connect the cables and close it.
4. Connect the negative (bare) wire to the ship's ground.
5. Connect the positive (white) wire to a fuse (5 amps) or circuit breaker at the ship's main 12 volts power supply.
6. The system is now ready to be turned on.

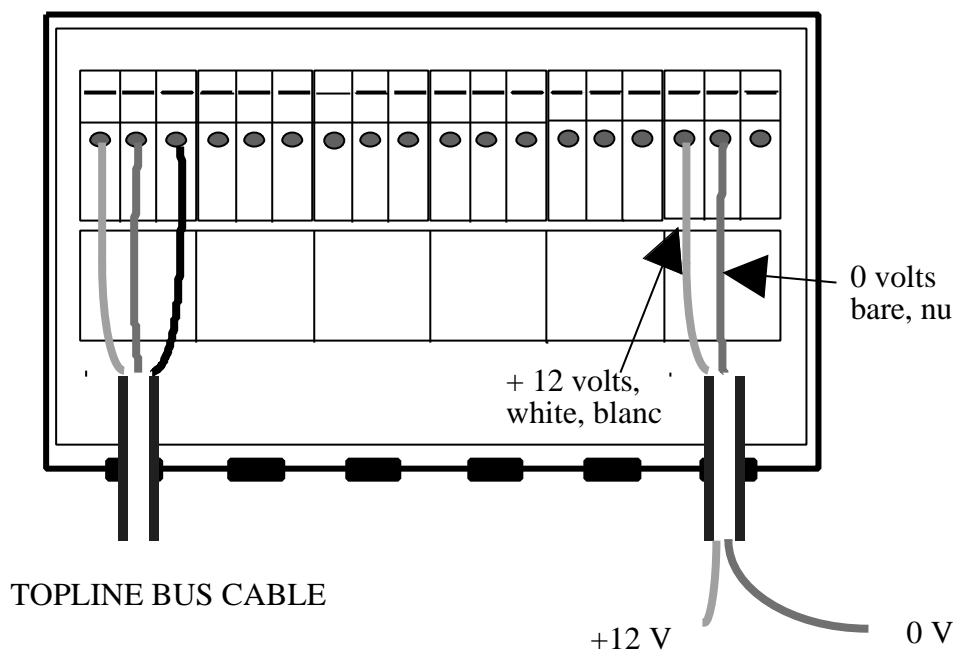

10. EXAMPLE OF INSTALLATION

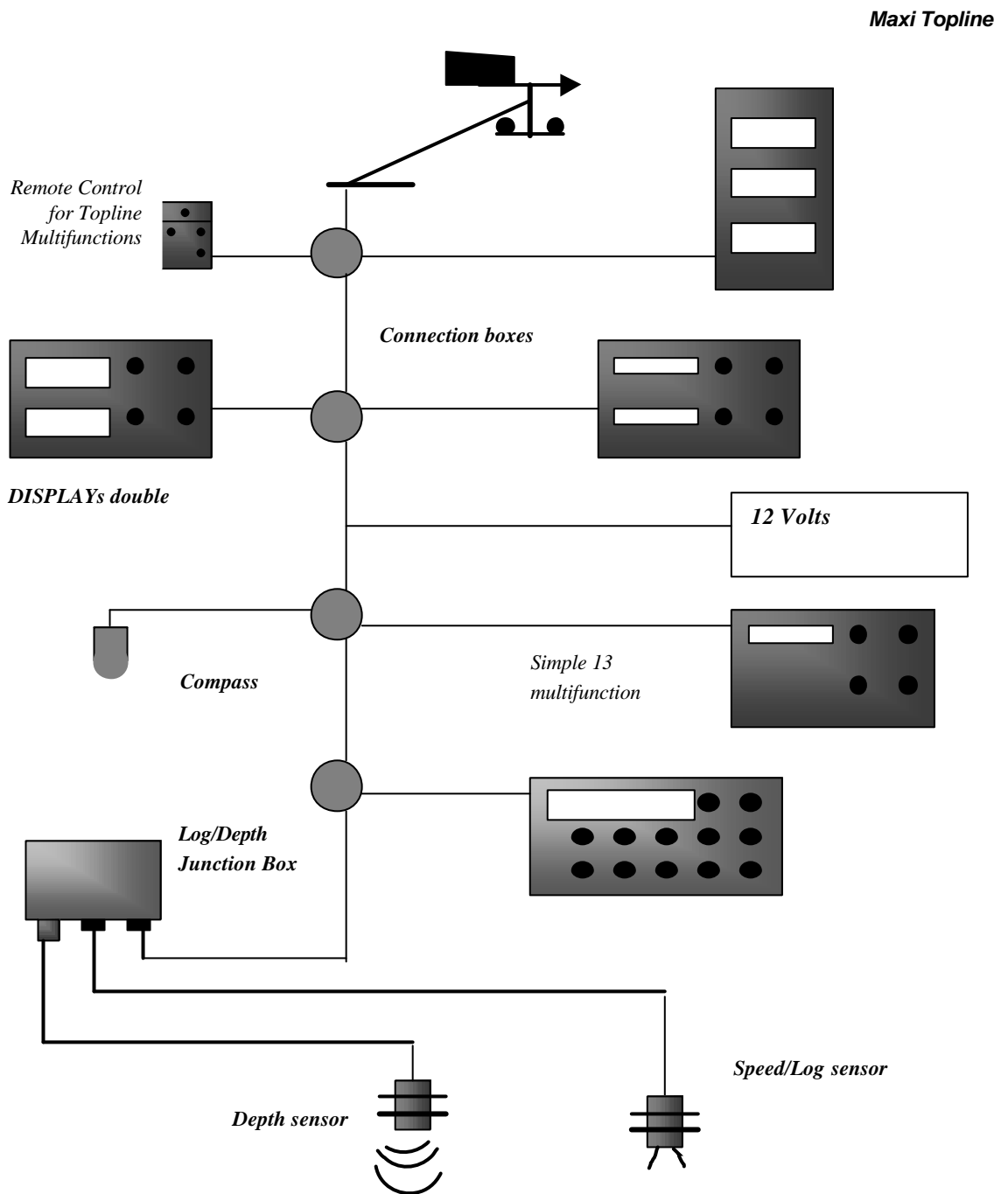

11. FIRST INITIALISATION OF THE BUS

11.1 ARCHITECTURE

The BUS or network is made of sensors and displays linked together by a 3 wires cable (0 v = bare wire, +12 v = white wire, data = black wire).

The BUS system is a proprietary protocol that is organised by one of the displays present on the BUS. This display is the “MASTER”, designated by you at the initialisation of the system. Every display has a designated number on the BUS that appears at the starting of the system.

0 = display NOT numbered
1 = master display
2 to 20 = slave display

The numbering of the displays is made as you like, but it can also depend of the type of displays you have.

If you have a Topline Datacom :

The Datacom is initialised in production to be the MASTER of the BUS on your installation. It then has the number 1.

If you have a remote control :

On the BUS, the Remote Control appears as a display and initialises as a display. Therefore, it has a number between 3 and 20. This remote control is able to act only on the displays which have a number lower than its own one. If you want to be able to act on all the displays, you then need to number it in last.

11.2 NUMBERING OF THE DISPLAYS

On the first starting of the system, all the displays show - - - - -
The BUS is not active as all the new displays have the number 0. The control of the BUS being taken care by the MASTER, you then need to designate one at the first starting.

To designate the MASTER :

You designate the MASTER by pushing on one button of this display. It then takes number 1.

The MASTER then display “CREAT LISTE” for a few seconds, and displays the data supplied by the sensors present on the BUS.

Note : If you want to put the Maxi or Hyper display as the MASTER, you can't number the remote control number 2. You will have to number it number 3 or more.

To designate the SLAVE displays :

Press on one button of a display, which will take number 2. The display then shows LISTE (meanwhile the MASTER displays CREAT LISTE for a few seconds and comes back to the data display). For a Maxi or a Hyper Topline, press on the C button.

Repeat this operation on all the displays with a minimum 5 seconds delay between each display.

Switch off the power

The displays now have their number and can communicate.

11.2.1 Normal Operation after initialisation :

After these settings, all the displays are numbered. At the starting, each display shows shortly its number and then the MASTER displays "CREAT LISTE". (meanwhile, it interrogates all the elements of the BUS to constitute the LIST), and then the number of all the displays present. (e.g. : 3 slave displays 2 3 4)

Note : if there has been an error during the numbering, you need to erase the number and restart the procedure.

11.3 RE-INITIALISING THE SYSTEM :

11.3.1 Simple or double multifunction

If there is a problem of communication on the BUS, the reason can either be a faulty connection or a conflict on the BUS (e.g., if there is a two MASTERS conflict on the BUS), you need to re-organise the network by following the procedure below :

- Switch off the power of the system
- Press and maintain one of the buttons of the display that you want to reset (number 0)
- Switch on the power with this button maintained
- As soon as the display shows 8888 and ring, loose the button and wait for the end of the ringing
- Switch off the power without pushing on any button
- The display is then reseted.
- Restart the numbering procedure on the displays you want to re-number as described in section 10.2.

11.3.2 Maxi and Hyper Topline

To number it to 0 :

- Switch off the system
- Press and maintain the C button
- Switch on the power
- After a second, loose the button
- Switch off the system without pushing any button

The maxi or hyper display then has the number 0. See the numbering procedure to re-number it.

11.3.3 Remote control

To number it to 0 :

- Switch off the system
- Press and maintain one of the low buttons of the remote control
- Switch on the power
- After a second, loose the button
- Switch off the system without pushing any button

The remote control then has the number 0. See the numbering procedure to re-number it so that it can act again on the displays.

11.4 TOPLINE DISPLAYS ERROR MESSAGES

EproM	EPROM faulty	These messages concern components mounted on the electronic boards, which have become faulty. The multifunction board has to be replaced.
RaM	RAM faulty	
9346	9346 faulty	

If the displays stay on CREAt or LIStE :	<ul style="list-style-type: none"> - Check for a short-circuit in a junction box between the black wire and other wires coming from another display or sensor - Check that there are no faulty items (display, sensor, calculator)
--	--

MAItrE AbSEnt	- The master display is missing in the system or there is a communication problem on the black wire. Check that there are no connection problems on the black wire, if the problem persists, re-init the system and name the master.
DEFAUt bAtt	- The BUS power supply battery or the voltage are too weak on the display
FAIL	- This message appears after a channel name (SP, Ad, etc) means that the related sensor is no longer sending data, the black wire is disconnected or the sensor is faulty
UoIR bUS	- This message appears if you try to go into the secondary channels of a sensor that is not detected by the BUS.